

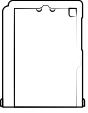









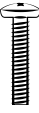

## Part Index

\*not to scale

- A  x1
- B  x1
- C  x2
- D  x2
-  x1
-  x1
-  x1
-  x1
-  x1
-  x1
-  x1
-  x1

**1** When using the Tough-Case™ with a Samsung Tab A 10.1 use 510 inserts. For use with the Samsung S6 Lite use 615 inserts. For use with the Tab A7 10.4 no inserts are needed and you can skip to step 2.

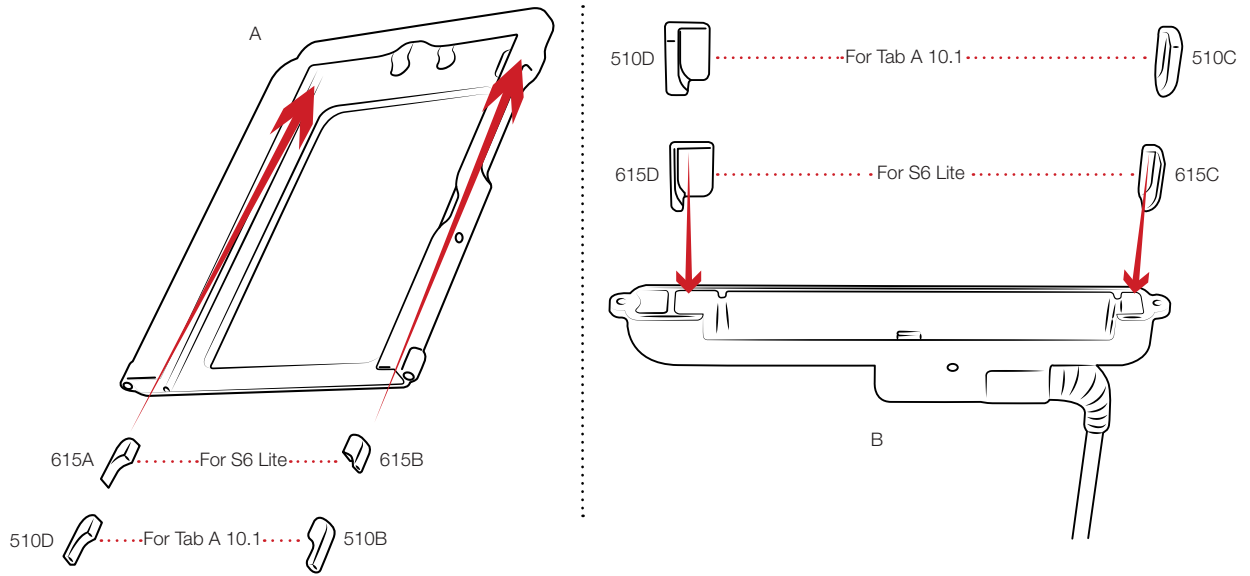

**2** Carefully insert the device into the prepped Bottom Enclosure (B) ensuring positive connection with the USB connector. Insert screws (C) through bottom enclosure (B) then through retaining o-rings (D). Slide top enclosure (A) over device and secure to bottom enclosure by tightening screws.

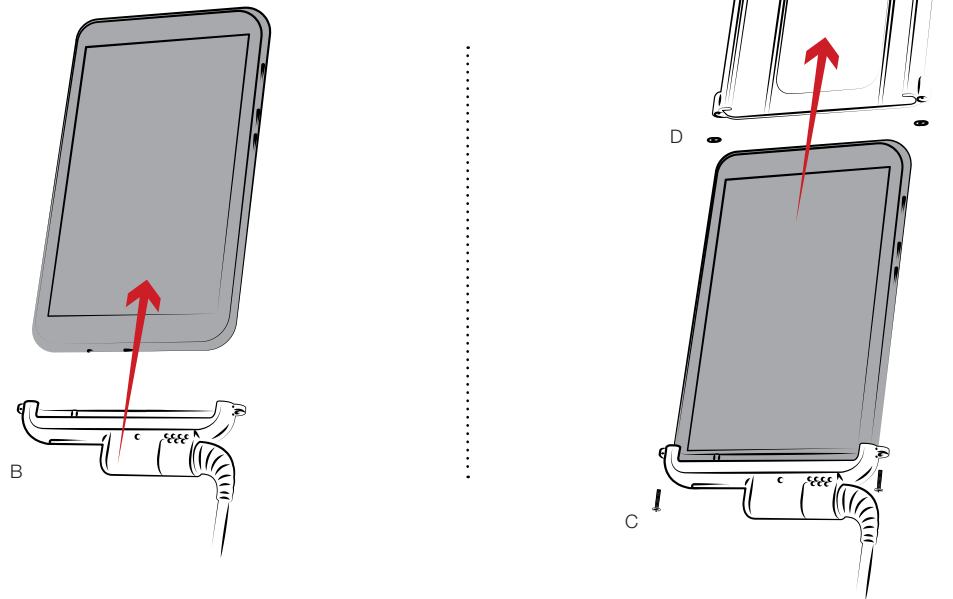

RPR-INS-TC-SAM50



### Safety Precaution

Do not install this product near or over an airbag deployment area or in a location that obstructs the driver's vision or interferes with vehicle operation. National Products, Inc does not assume responsibility or liability for any such personal injury, death or property damage.