















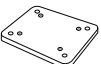



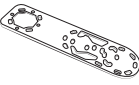



Parts Index

* not to scale

- A IntelliSkin® 
- B Uni-Conn™ Dock 
- C Dock Mounting Hardware Pack
#8-32 x 1¼" Screws (x2) 
#8-32 Nylock Nuts (x2) 
Lever Stop (x1) 
- D Double Ball Mount 
- E Backing Plate 
- F Backing Plate Hardware
#8-32 x 1" Screws (x4) 
#8 Lock Washers (x4) 
#8 Washers (x4) 
- G Mounting Bracket 
- H Speaker 
- I Speaker Mounting Hardware Pack
#8-32 x 5/8" Screws (x2) 
#8-32 Nylock Nuts (x2) 
- J Microphone with Bracket 
- K Microphone Mounting Hardware Pack
#6-32 x 5/16" Screws (x2) 
#6-32 Nylock Nuts (x2) 
#10 x 3/4" Screws (x2) 
- L Audio to USB-A Cable Adapter 
- M Hardwire Charger 
- N USB-C Cable Clamp Kit 
- O USB-A Cable Clamp Kit 

Patented & Pats. Pend.

- 1 Assemble (D) Double Ball Mount with (G) Mounting Bracket and (B) GDS® Uni-Conn™ Dock using the (C) Dock Mounting Hardware Pack. Lever Stop must be positioned between dock and mounting bracket, as shown.

NOTE: Failure to use Lever Stop will void warranty

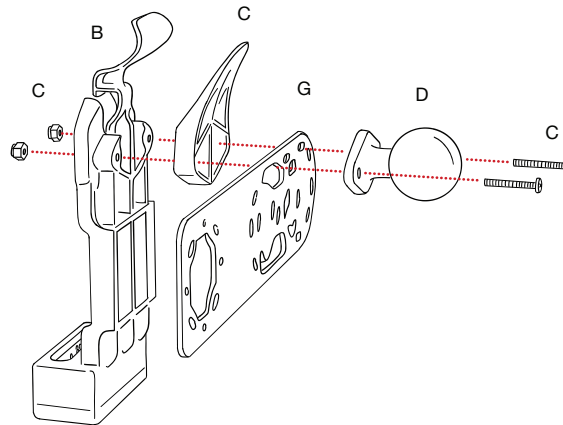

Completed Step 1 Assembly View

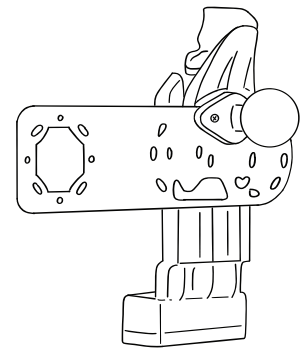

- 2 Connect (D) Double Ball Mount to (E) Backing Plate using (F) Backing Plate Hardware Pack.

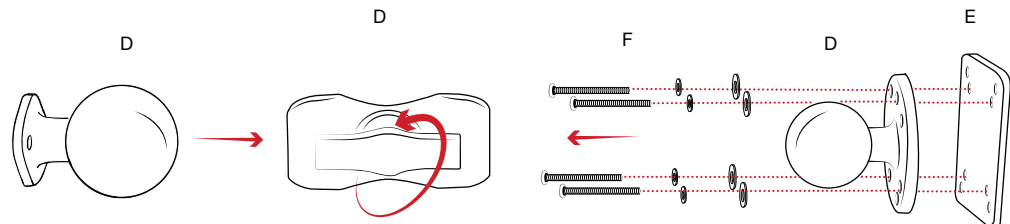

- 3 Connect (H) Speaker to (G) Mounting Bracket using (I) Speaker Hardware Pack.

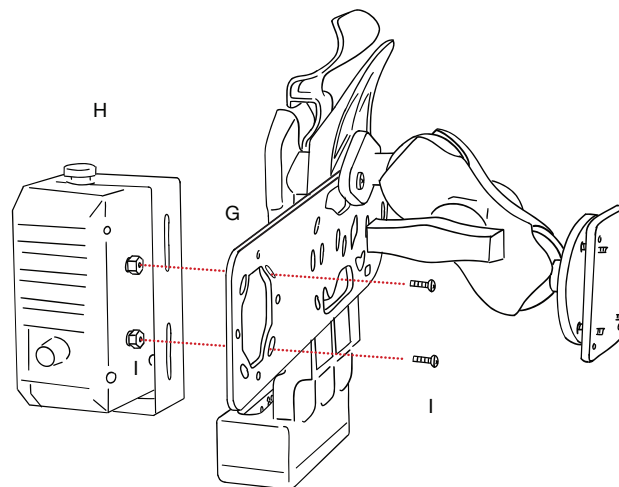

Completed Step 3 Assembly View

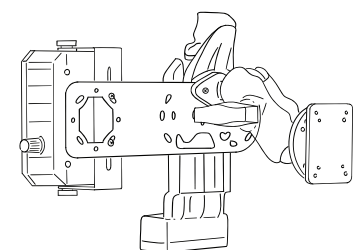

RMR-INS-GDS-PTT2



Safety Precaution

Do not install this product near or over an airbag deployment area or in a location that obstructs the driver's vision or interferes with vehicle operation. National Products, Inc does not assume responsibility or liability for any such personal injury, death or property damage.

Wiring and Retention Diagram

Patented & Pats. Pend.

Uni-Conn[™] Dock (B)

Mic (J)

Speaker (H)

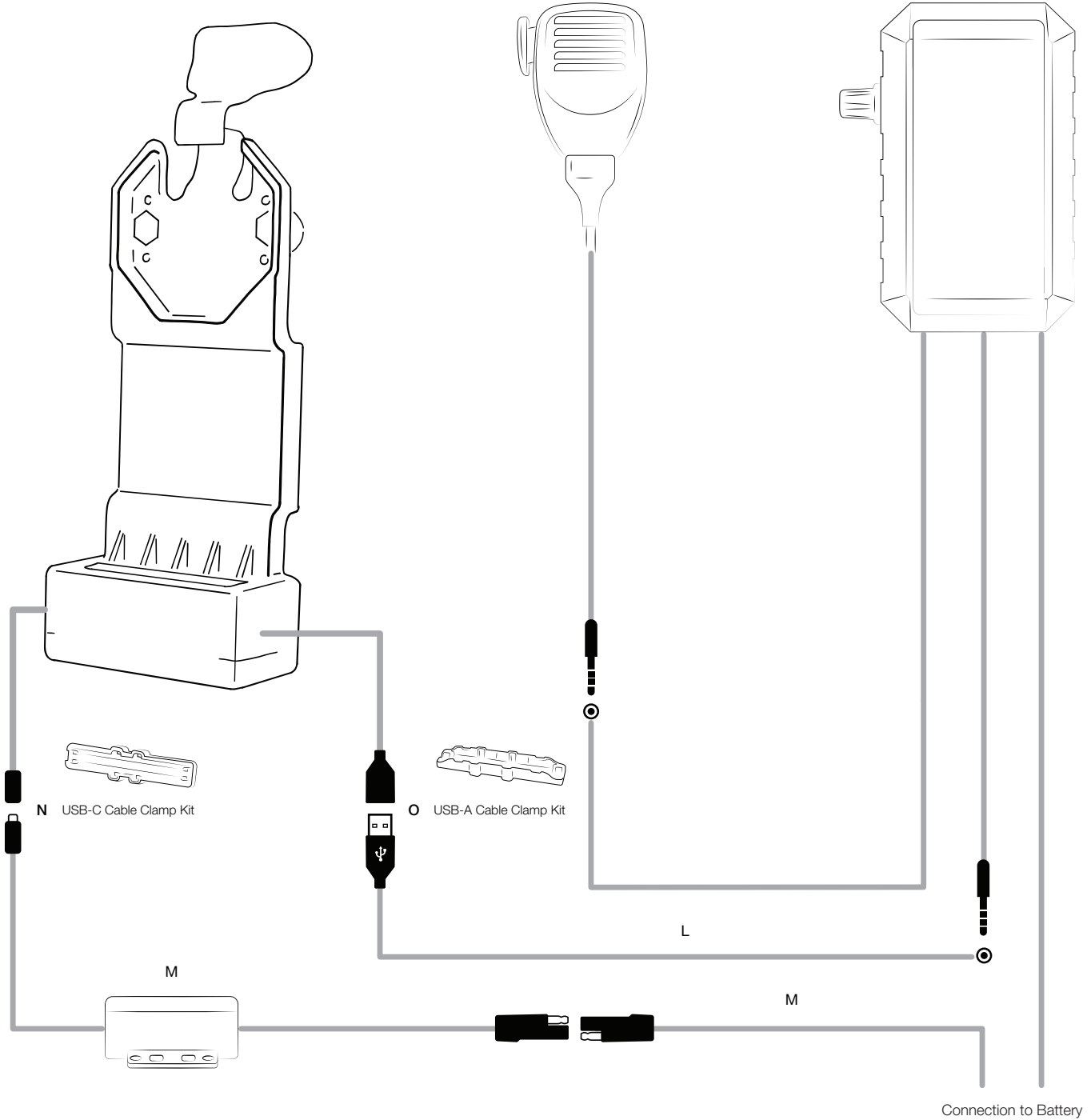

RMR-INS-GDS-PTT2



Safety Precaution

Do not install this product near or over an airbag deployment area or in a location that obstructs the driver's vision or interferes with vehicle operation. National Products, Inc does not assume responsibility or liability for any such personal injury, death or property damage.