

## Supplies

Choose any of the below cleaning agents. Whatever you choose to use, make sure it's made to remove film, grease, oils, dried liquids, or debris. This also includes 70% Isopropyl Alcohol, CFC-free electronic contact cleaners with hexane.

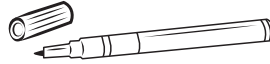

DeoxIT® Pen

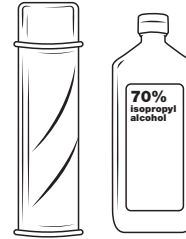

Cleaning Agent



Q-tips

## For Maintenance

Use 70% Isopropyl Alcohol for routine maintenance and light buildup of debris.



## For Connection Issues

Use DeoxIT® Pen for extreme buildup of debris, or if you're experiencing loss of connection.



## Cleaning

Uncap your DeoxIT® Pen, or wet the end of your Q-tip with the cleaning agent and twist in a circular motion against each pogo pad 2-4 times each pad. Check pad for cleanliness and repeat the process until thoroughly cleaned.

Note: After using DeoxIT®, perform one cleaning with isopropyl alcohol.

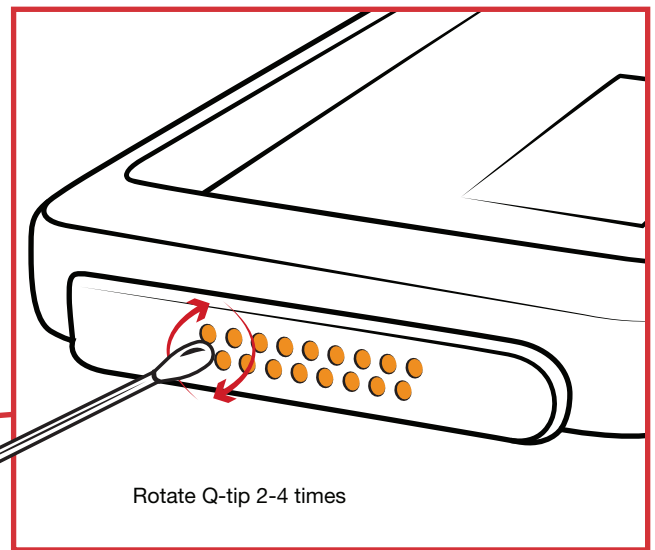
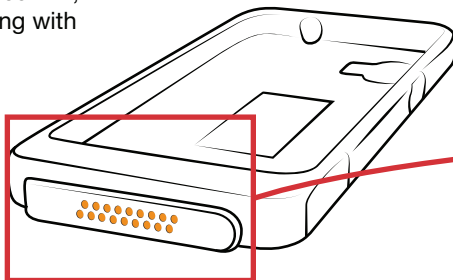

Dirty



Clean

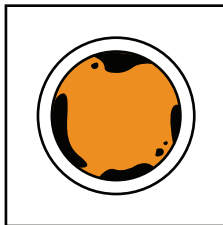

Cleanest

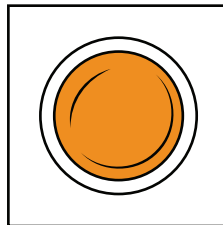

Evidence of residue on Q-tip

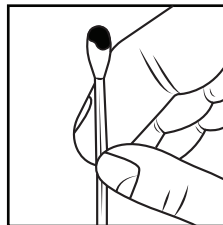

3-year warranty on all electronic components/Lifetime Warranty on all non-electronic components

The exclusive NPI Lifetime Warranty states that all GDS® non-electronic components and parts are warranted against defect in materials and workmanship for the life of the product or part. NPI's Lifetime Warranty covers the product or its components only. The mount device is not covered under the Lifetime Warranty and will not be replaced if damaged as a result of mount failure. This warranty is expressly limited to persons in the United States, and all foreign countries who purchase GDS® for resale or use in the ordinary course of the buyer's business. This warranty does not cover any product or part that has been abused, worn out, heated, ground or otherwise altered, used for a purchase other than that for which it was intended, or used in a manner inconsistent with any instruction regarding its use.

GDS®, IntelliSkin®, GDS® Tech™, GDS® Green™ and GDS® Compatible™ are trademarks or registered trademarks of National Products Inc. The Distinctive "D" product shape of the GDS® connector is a trademark of National Products Inc. Patents and Trademarks: rammount.com/ip